

Wireless Wall Switch

LWST-615



Specification:

Function: On / Off / Dimmer
Frequency: 433.92MHz
Battery: 3V CR2032 lithium cell battery (included)

Overview:

1 channel wireless wall switch.

For controlling ON / OFF receivers and dimmer receivers.

Easy installations with either screw fix into current wall box or affix any location with adhesive tape.

Installation:

1. Screw Base to wall.
2. Fix Frame to Base.
3. Fix Rocker to Frame.

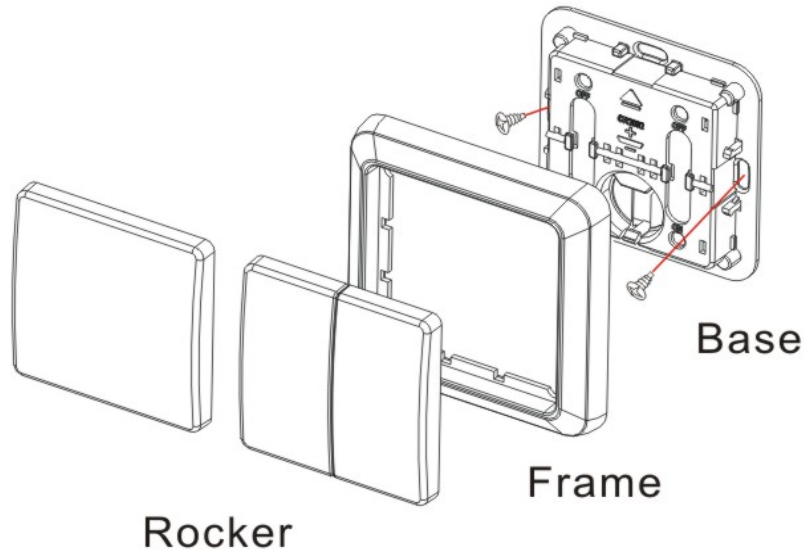

Pairing:

Pairing using **LEARNING MODE**:

1. First choose the desired receiver(s) that you wish to control.
2. Press the **'Learn'** button once (LED will flash), this will now enter learning mode.
3. On the wall switch press the **'ON'** button intended to be paired; the load will flash twice to confirm that the remote control is now paired.

NOTE: Learning mode lasts for 12 seconds; if no signal is given to the receiver then it will automatically exit learning mode without pairing the device.

To exit learning mode manually, simply press the **'Learn'** button again.

! If, during learning mode the load does not flash to confirm, this means that the receiver's memory is **FULL** and no further wall switch may be paired unless one of the existing wall switch is first unpaired (see below).

Unpairing:

Removing single device:

1. With the receiver that you intent to un-pair press the **'Learn'** button once (LED will flash), this will now enter learning mode.
2. On the wall switch press the **'OFF'** button intended to be unpaired; the load will flash twice to confirm that the wall switch is now unpaired.

Operation:

ON/OFF Function:

Press the 'ON' button on wall switch, the lights will gradually illuminate.

Press the 'OFF' button on wall switch, the light will gradually turn OFF.

Dimming Function:

1. Make sure the load (light) is switched ON.
 2. On the wall switch press the ON button again, the loads will start to dim.
 3. To stop at the desired brightness level, press the ON button again.
- ※ Dimming level dims in cycle, during the cycle if no signal is given 『 with 4 cycles it will stop at 100% brightness 』 .

! After setting a dim level using the wall switch the light is then switched OFF, the next time that the light is switched back ON again the load (light) will return to the previous stipulated brightness.

Battery Replacement:

3V CR2032 lithium battery is included.

When the battery voltage is low, the transmission range will be reduced accordingly.

1. Remove rocker cabinet and press the battery holder.

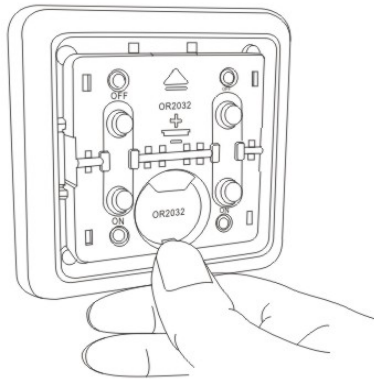

2. Remove battery.

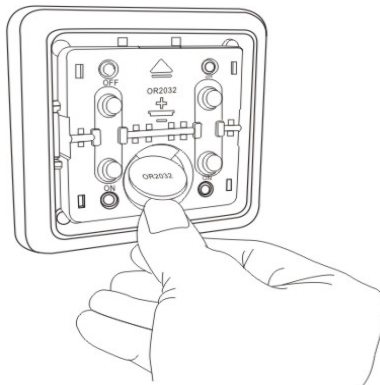

3. Replace with a new battery then place back the rocker cabinet.

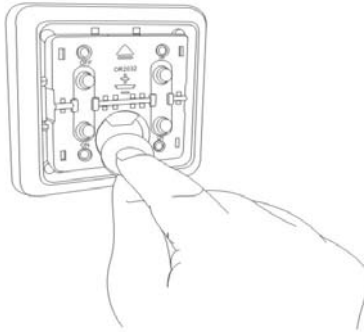

Troubleshoot:

Problem:I cannot pair my wall switch with the receiver.

Solution:The memory on receiver is full, please delete one or more memory and try pairing again.